

# Mosaic™ dimmer switch, 400 W, all loads

Cat. No(s) : 784 01 - 792 04

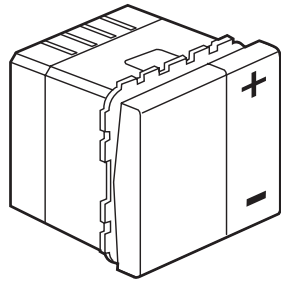

784 01 / 792 04

## CONTENTS

Page

1. General characteristics	1
2. Range	1
3. Preparation	1
4. Overall dimensions	1
5. Connection	1
6. Operation	2
7. Technical characteristics	3
8. Cleaning	3
9. Conformity - Approvals	3

## 1. GENERAL CHARACTERISTICS

Dimmer switch for controlling lighting devices. Dimmer switch with level memory for switching on with the same light intensity used before switching off or mains cut-off.

Cat. No..	240 V		100 V		Use
	Max.	Min.	Max.	Min.	
784 01 792 04	400 W	40 W	200 W	20 W	Incandescent lamp
	400 W	40 W	200 W	20 W	230 V halogen lamps
	400 VA	40 VA	200 VA	20 VA	Halogen lamp with ferromagnetic transformer
	400 VA	40 VA	200VA	20 VA	Halogen lamp with electronic transformer

**Important :** take account of transformer losses when calculating power. Transformers must be loaded to over 60% of their power

## 2. RANGE

	Designation	Cat. No.	No. of modules	Fixing method	Weight (g)
	Dimmer switch, 400 W, all loads	784 01	2	Cage-type	56
	Dimmer switch, 400 W, all loads Aluminium cover plate	792 04	2	Cage-type	56

## 3. PREPARATION

For mounting on Mosaic plates and support frames (2 modules at least).

The mechanisms can be flush-mounted or surface-mounted. The mechanisms are mounted on thin walls using adapter Cat. No. 802 91 (2 modules).

## 3. PREPARATION (Cont'd)

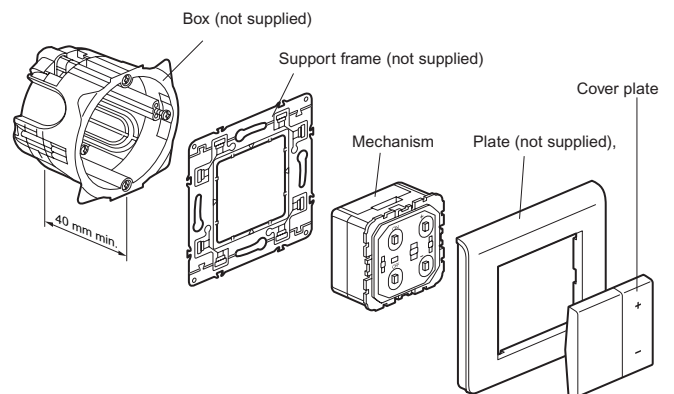

## 4. OVERALL DIMENSIONS

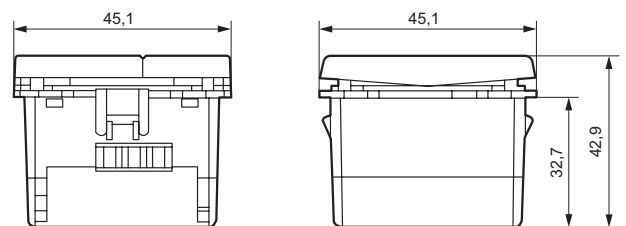

## 5. CONNECTION

No. of terminals	3
Terminal type	Cage-type connector
Terminal capacity	2 x 1.5 mm <sup>2</sup> or 1 x 2.5 mm <sup>2</sup>
Tool	3.5 mm flat-blade screwdriver or Philips No. 1 or posidrive No. 1 or mixed size 0

## 5. CONNECTION (Cont'd)

### 5.1 Connection of one lighting point by replacing a switch (factory mode)

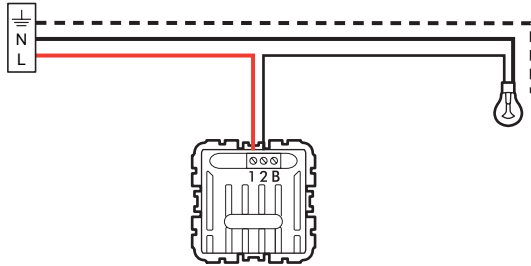

The phase can be connected to either terminal 1 or 2.

### 5.2 Connection of several lighting points by combining non-illuminated pushbuttons (factory configuration)

(Light dimming from all control points)

Use of the pushbutton connected to the dimmer switch :

- A short press to switch on/switch off (< 2 s)
- A long press for the dimming function (> 2 s)

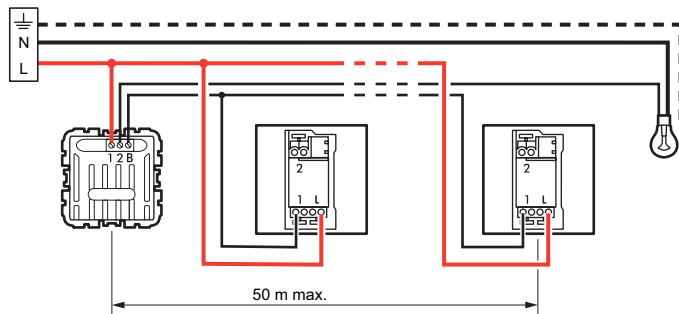

To initialize this "pushbutton" operating mode, unclip the rockers, then simultaneously press on the + and - for at least 2 seconds.

**Important :** The dimmer switch includes a "remote control switch" function that is incompatible with an installation that already contains remote control switches and pushbuttons.

### 5.3 Connection of 2 lighting points with a two-way switch (light dimming from a dimmer switch only)

For this type of use, the terminals L and 1 of the two-way switch should be interconnected.

Initialization : unclip the rockers then, when switching on, simultaneously press the ON and OFF buttons for 2 seconds.

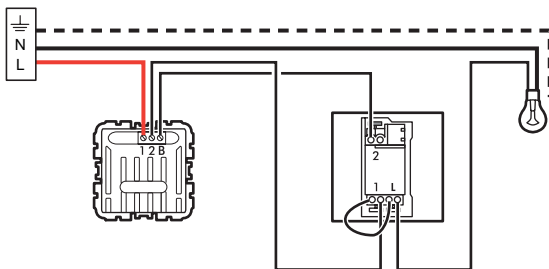

## 5. CONNECTION (Cont'd)

**Important :** The dimmer switch can be connected to either the lamp or phase side; failure to strictly comply with the wiring diagrams, and failure to keep within the values indicated in the table (voltages, power, temperature, frequency, etc.) can destroy the device.

## 6. OPERATION

To initialize the different types of use, unclip the rockers and then press the buttons indicated in the table for 2 seconds.

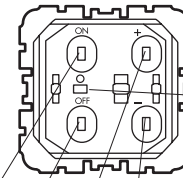

The AUX button is to be activated using a screwdriver.

Types of use	ON	OFF	+	-	AUX	Operations
Reset to factory configuration (load recognition, capacitive mode, pushbutton mounting, level memory)	X	X	X	X		
Level memory activation	X	X	X			
Level memory deactivation	X	X		X		
Mounting by combining pushbuttons			X	X		
Forced capacitive mode (no load recognition)	X	X		X	X	
Forced inductive mode (no load recognition)	X	X	X		X	
Children's rooms (preset levels + nightlight)	X	X			X	
Preset level mode			X	X	X	
Dimmer switch mode		X	X		X	

## 6. OPERATION (Cont'd)

Remark : The dimmer switch is fitted with a LED located behind the rockers ; this LED can show various statuses with automatic load recognition :

- yellow : capacitive mode
- red : inductive mode
- flashing LED : forced mode (yellow = capacitive ; red = inductive).

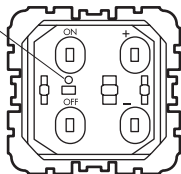

## 7. TECHNICAL CHARACTERISTICS

### 7.1 Mechanical characteristics

Impact tests : IK 02

Penetration by solid/liquid bodies : IP 20

### 7.2 Material characteristics

Base + cover : Polycarbonate

Rockers : ABS RAL 9003

### 7.3 Electrical characteristics

Self-extinguishing : 650°C / 30 s

Voltage : 100 / 240 V<sub>~</sub>

Consumption : 0.6 W on standby

4 W at max. load

Frequency : 50 / 60 Hz

### 7.4 Climatic characteristics

Storage temperatures : - 10°C to + 60°C

Operating temperatures : 0°C to + 35°C

## 8. CLEANING

Surface cleaning with a cloth.

Do not use : acetone, tar remover, trichloroethylene.

### 8.1 Resistance to cleaning agents

Resistance to the following agents : Hexane (EN 60669-1), Methylated spirits, Soapy water, Diluted ammonia, Diluted pure bleach 10%, Glass cleaning substance, Pre-impregnated wipes.

### 8.2 Resistance to hospital-type cleaning agents

Resistance to the following agents : Anios, Surfianos, Bactilysine, Diluted hydrogen peroxide (35%).

**Caution** : A preliminary test should be carried out if other specific cleaning products are to be used.

## 9. CONFORMITY - APPROVALS

Approvals in process : NF - BBJ - VDE - GOST